



**PFE-2010-SC, Mobile Filter Unit**  
Designed for removal of dusts and Fumes  
during manufacturing processes.

888-372-0050 x4  
Sales@IAP-AirProducts.com  
www.IAP-AirProducts.com



**PFE-2010-SC Portable Fume Extractor**

IAP Air Products • 888-372-0050 x4 • Sales@IAP-AirProducts.com

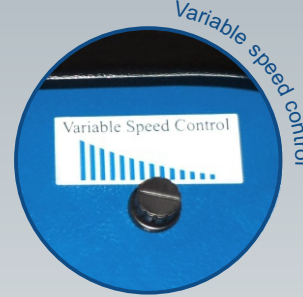
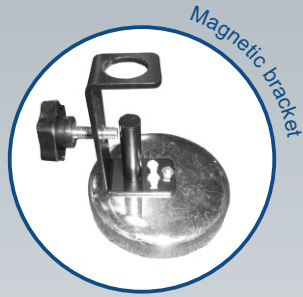
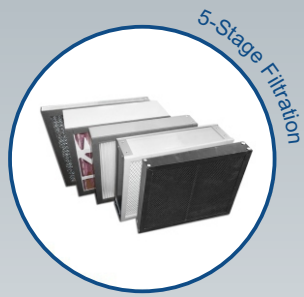

**Applications:**

- Welding Fume Collection
- Grinding Dust Collection
- Dry Dust Collection
- Fume Collection

**Features:**

- 5-Stage Filtration
- Filter Indicator
- Lightweight & portable design
- Dual carbon-motor design
- Variable speed control
- Heavy gauge powder coated steel

**Technical Data:**

Airflow (Low Speed)	100 cfm
Airflow (High Speed)	230 cfm
Motor	800W *2
Power Supply	120V / 1
Dimension	28.6" x 13.3" x 19"
Inlet Size	Ø2-1/2"
1st Filtration	Aluminum Mesh
2nd Filtration	85% Prefilter
3rd Filtration	Pleated Filter
4th Filtration	HEPA
5th Filtration	Activated-Carbon Filter
Noise@3ft. / 6.5ft. / 10ft.	73dB / 69.7dB / 68dB

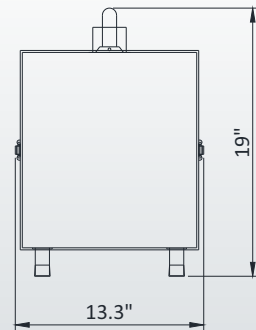
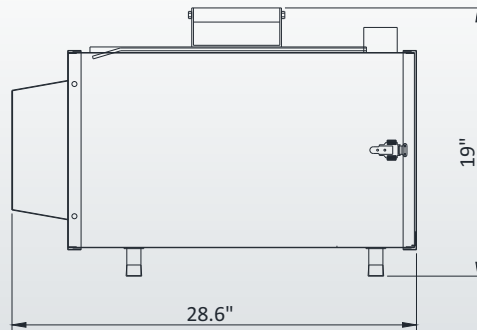
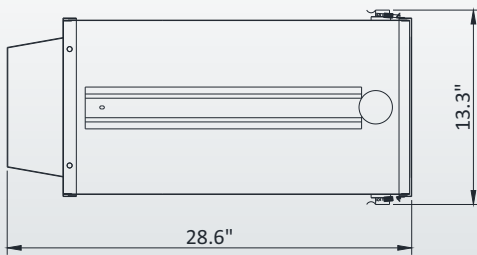

**Dealer Information / Contact:**

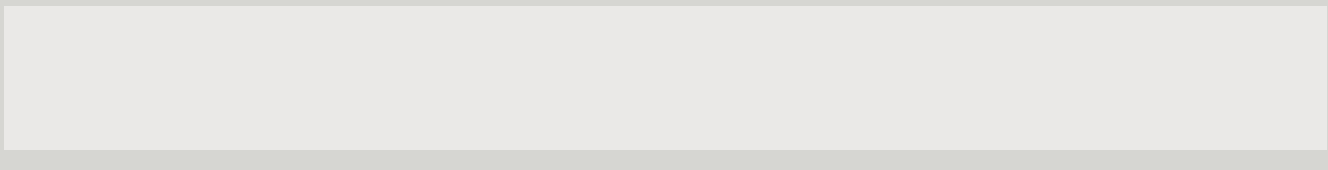

888-372-0050 x4  
 Sales@IAP-AirProducts.com  
 IAP Air Products  
 2544 Highway 70 East  
 Cookeville, TN 38506

**SINGLE SOURCE FOR**  
 Fume / Welding / Dust Arms  
 Ambient Air Cleaners, Mobile Welding Units  
 Dust Collectors, Vehicle Exhaust, etc.  
 at [www.IAP-AirProducts.com](http://www.IAP-AirProducts.com)

IAP Air Products · 888-372-0050 x4 · Sales@IAP-AirProducts.com

**PFE-2010-SC Portable Fume Extractor**